

To the attention of Medical Device Vigilance
Manager / Central Pharmacy

Saint Priest, 22 June 2022

Subject: URGENT - FIELD SAFETY NOTICE – Integra – Codman® CereLink® ICP Monitor, Model: 826820: ICP Monitor Reading Default – Field Safety Notice

Legal manufacturer:

INTEGRA LIFESCIENCES PRODUCTION CORPORATION, 11 Cabot Boulevard, 02048 Mansfield, MA, 02048 USA – SRN:US-MF-000009189

EC Representative:

INTEGRA LIFESCIENCES (France) SAS – Immeuble Séquoia 2 – 97 Allée Alexandre Borodine – 69800 SAINT PRIEST, France – SRN : FR-AR-000002474

Medical device(s):

The Codman® CereLink® ICP Monitor (ICP Monitor) is a standalone portable device that continuously monitors intracranial pressure (ICP). When connected to a Codman® CereLink® ICP Sensor (ICP Sensor), ICP Monitor provides a numeric display of the mean ICP, ICP waveform and mean ICP trend. For detailed waveform analysis, the ICP Monitor generates real time digital data and an output signal that can be interfaced directly to the pressure channel input on most patient bedside monitors. The entire CereLink® System is comprised of the ICP Monitor, ICP Sensor, and cables.

Primary clinical purpose of device(s):

The ICP Monitor is intended for use as an interface between compatible strain-gauge type pressure transducers and standard physiological pressure monitoring systems. The ICP Monitor is also intended for use as an independent pressure monitor for displaying the mean, systolic and diastolic values of a physiologic pressure waveform in the absence of an external patient monitor.

Concerned reference and serial numbers:

826820 - Codman® CereLink® ICP Monitor
All serial numbers ranging from CLK2111003 to CLK2215542



Dear Valued Integra Customer,

Out of an abundance of caution, Integra LifeSciences is voluntarily conducting a Field Safety Notice in the form of this customer communication for the Codman® CereLink® ICP Monitor, while we finalize our root cause investigation. The impacted product is listed in Table 1 below.

Product Name	Catalog Number	UDI-DI	Serial Numbers	Distribution Dates
Codman® CereLink® ICP Monitor	826820	10381780533788	All serial numbers ranging from CLK2111003 to CLK2215542	From June 2021 to May 31, 2022

Table 1: Product and Distribution Information

Our records indicate that you have received a Codman® CereLink® ICP Monitor. The intent of this letter is to provide troubleshooting techniques related to the error described below as an additional risk mitigating factor.

Integra has received complaints associated with 'ICP readings drifting to -50 mmHg' (out-of-range readings). When this error occurs, the system message: "sensor or extension cable failure!" appears on the ICP Monitor. As of May 2022, 67 reportable complaints globally have occurred on the CereLink® System. 15 CereLink® System complaints have included a report of an additional procedure to place a new ICP sensor. This is the worst-case harm reported, resulting in a 0.54% occurrence rate. Please refer to the "Risk to Health" section for further information on this harm and all other harms that may occur due to the out-of-range readings and their respective likelihood.

Risk to Health:

A Health Hazard Evaluation (HHE) conducted by Integra quantified the following risks based on the number of CereLink® System complaints received for the out-of-range readings, with the exception of the "Critical" severity harm, which is estimated based on our current risk management documents since no complaints have been received due to a critical harm associated with the CereLink® monitor. The highest confirmed risk was "Serious," indicating there is a possibility (0.54%) that if an out-of-range reading occurs, it may lead to the patient undergoing an additional procedure to place another CereLink® ICP sensor.

Harm	Risk Severity	Likelihood That An Adverse Health Consequence Could Occur
Monitor displayed error message that was able to be resolved with basic troubleshooting such as unplugging or swapping out cables, power cycling, etc., or occurred in a Demo or prior to surgery (temporary discomfort/inconvenience to user)	Negligible	0.75%
Monitor displayed error message that required patient to be sent for additional imaging and/or the sensor to be removed (incorrect treatment, causing minor, transient, or self-limiting injury).	Moderate	0.39%
Monitor displayed error message that resulted in the patient undergoing an additional procedure to place another ICP sensor (incorrect treatment, causing injury requiring treatment beyond standard of care: additional procedure to place another CereLink® ICP sensor).	Serious	0.54%
Monitor displayed error message that resulted in incorrect treatment, causing herniation and/or brain death.	Critical	0.000018%*

* This is an estimate based on our current risk management documents. Zero (0) complaint has been received due to the critical harm associated with the CereLink® monitor.

Table 2: Identified harms, severity and likelihood

The risks mentioned above have been assessed based on standard ISO 14971 and other applicable regulations listed in our internal procedures.

The following risk mitigating factors are currently in place:

- Per standard clinical practice, patients are consistently monitored at the patient bedside, making it more likely that an abnormal ICP would be detected using clinical exam and other vital signs.
- Audible and visual alarms on the CereLink® ICP Monitor are triggered in the event of an out-of-range reading to inform the user that the failure mode is occurring (see Figures 1 and 2).



Figures 1 (left) and 2 (right): Visual alarms including display and flashing light alarm

Use Recommendations:

Per the Instructions for Use (IFU), it is recommended to leave the ICP Monitor connected to the CereLink® Power Supply during routine use. The ICP Monitor includes a rechargeable lithium-ion battery that supplies power to the ICP Monitor for at least two hours when the battery is fully charged. The battery should only be used for short periods of time when a power supply is not feasible, e.g., during patient transport.

The ICP Sensor must always be handled with care to protect the tip from impact.

Avoid direct contact with the transducer (sensing element) at the tip of the device.

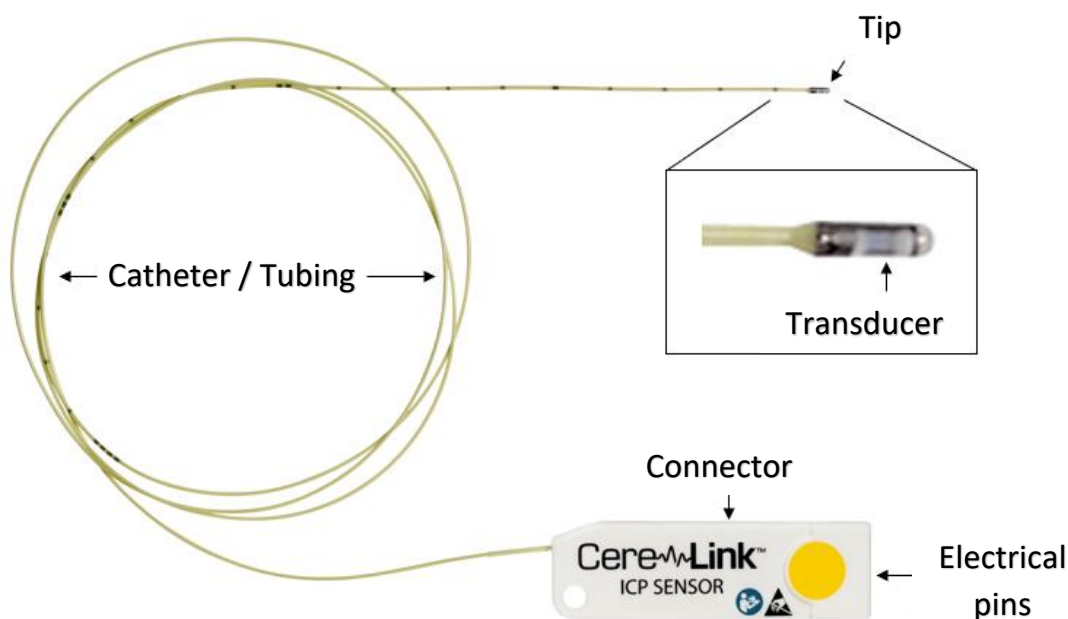

Avoid touching the sensor's electrical connector pins.

CereLink Sensor

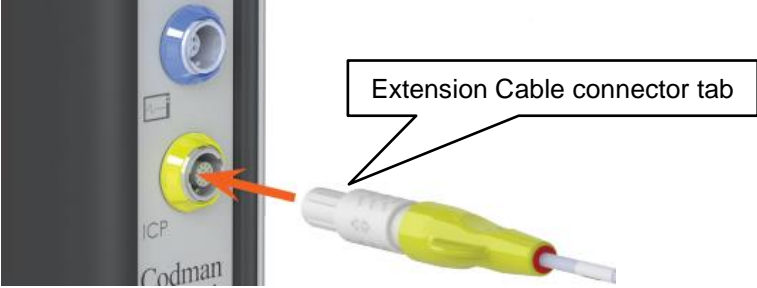
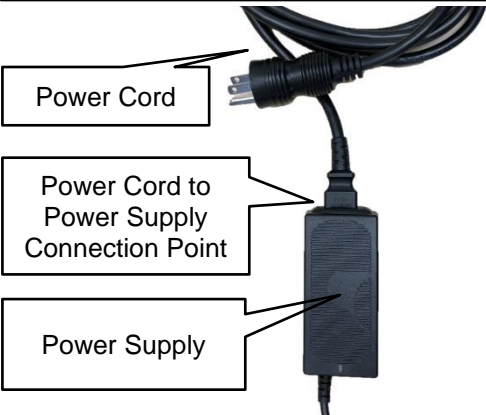

Troubleshooting Techniques:

If you encounter an out-of-range reading, please follow the troubleshooting techniques described below. If the issue persists, please contact your Integra Sales Representative.

1.	<p>Make sure the CereLink® ICP Sensor is connected correctly (fully seat) into the CereLink® ICP Extension Cable (included with the monitor; also available separately under product code 826845).</p> 
2.	<p>Make sure the CereLink® ICP Extension Cable is connected correctly to the CereLink® ICP Monitor.</p> <ul style="list-style-type: none"> • Extension Cable connector tab and arrows should face forward, in same direction as the monitor screen. • Push yellow connector into yellow port until you hear a click. 
3.	<p>Make sure to use a CereLink® Power Supply (included with the monitor; also available separately under product codes 826822 and ensure that the CereLink® Power Supply is grounded (i.e., confirm CereLink® Power Supply plug is unmodified and properly connected to a hospital grade system). See Figure 3 below.</p>
4.	<p>Ensure patient monitor and any data acquisition systems (such as a laptop) are connected to a properly grounded power supply. See Figure 4 below.</p>
5.	<p>The CereLink® Power Supply comes with the CereLink® Monitor. The connection between the CereLink Power Supply and the outlet could come in two configurations: 1) a power cord or 2) a replaceable plug. Please ensure both are properly attached (see below).</p> <div style="display: flex; justify-content: space-around;"> <div data-bbox="268 1527 758 1989"> <p style="text-align: center;">Power Cord Configuration</p>  <p>Power Cord</p> <p>Power Cord to Power Supply Connection Point</p> <p>Power Supply</p> </div> <div data-bbox="790 1527 1391 1960"> <p style="text-align: center;">Replaceable Plug Configuration</p>  <p>Replaceable Plug</p> <p>Power Supply</p> </div> </div>

6.	Move the CereLink® ICP Monitor away from other devices that may cause electrical interference. Avoid running the power supply and ICP extension cables along other devices power cords or cables. We recommend contacting your Biomedical Engineering department to review proper cord management.
7.	If problem persists, replace CereLink® ICP Extension Cable.
8.	If problem persists, disconnect the CereLink® ICP Sensor from the CereLink® ICP Extension Cable and wait for 30 minutes before reconnecting.
9.	If problem persists and ICP monitoring is still required, replace the CereLink® ICP Sensor or switch to an alternate patient monitoring method

Figure 3: Power Supply Plug

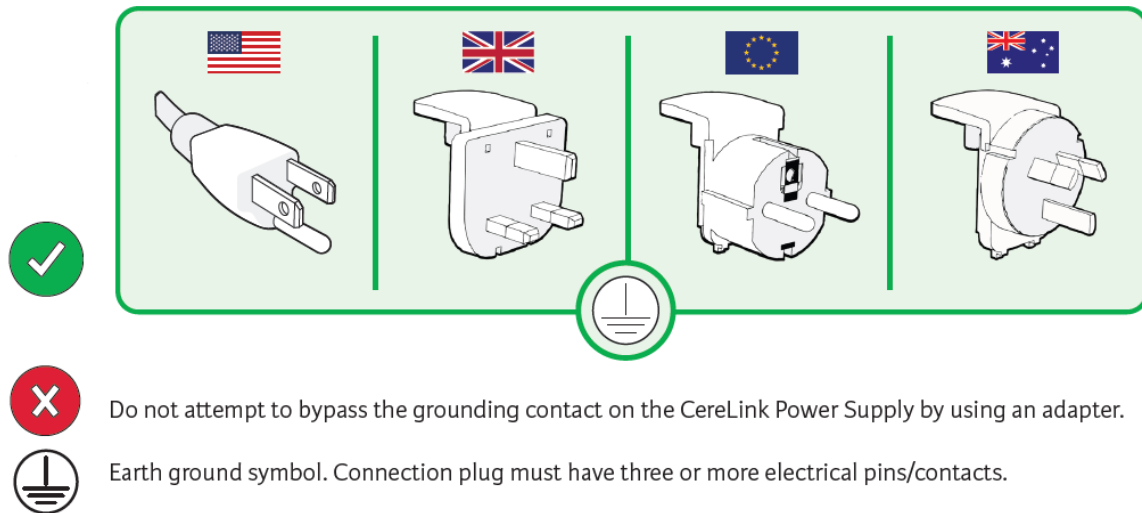
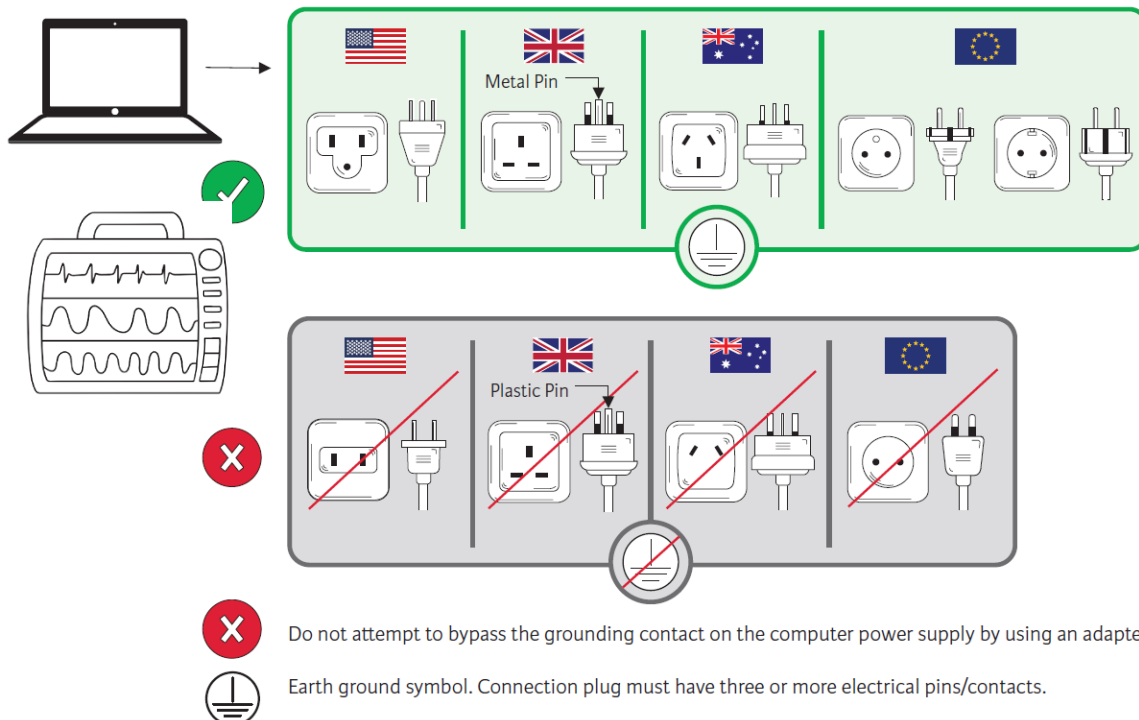

Figure 4: Power Supply Connection



Actions to be Taken by Customers:

1. If you are not experiencing the issue described in the letter or are able to resolve the issue based on the troubleshooting techniques above, you may continue to use the CereLink[®] monitors at your facility.
2. Please review and understand the information provided in this letter. Should you encounter the failure identified, please follow the troubleshooting techniques described above in this letter.
3. Complete the attached "Reply Form" (even if you have no product on hand or have not experienced the issue) and return the completed form by email to emea-fsca-neuro@integralife.com, or Fax to +33 (0)4.3747. 59.30. By filling this form, you confirm that you have received this Safety Notice and you intend to fully comply with this notification. **We expect a response within 3 weeks.** You also confirm that this notification has been forwarded to every concerned person in your organization.
4. We also recommend that you retain a copy of the form for your records.

The receipt of this form ensures that Integra has achieved a level of effectiveness in communicating this information.

If you have any further questions about the Field Safety Notice or the CereLink[®] product, please feel free to contact your Integra Sales Representative.

National Competent Authorities may perform audits of field actions of this nature to verify that our customers have been notified and understand the nature of the field action being taken.

The National Competent Authority of your country has been alerted of this Field Safety Corrective Action.

Thank you for your cooperation with this Field Safety Corrective Action and for returning the attached Reply Form.

Please feel free to contact our Post Market Surveillance Department at emea-fsca-neuro@integralife.com for any additional questions. Your cooperation is appreciated, and we thank you for your continued collaboration.

Yours Sincerely,

xxx

Enclosed: Field Safety Notice Customer Reply form (2 pages)

CUSTOMER REPLY FORM

1. Field Safety Notice (FSN) information	
FSN Reference number*	FSN-2022-HHE-006
FSN Date*	22/06/2022
Product/ Device name*	Codman® CereLink® ICP Monitor
Product Code(s)	826820
Batch/Serial Number (s)	All serial numbers from CLK2111003 to CLK2215542

2. Customer Details	
Account Number	
Healthcare Organization Name*	
Organization Address*	
Department/Unit	
Shipping address if different to above	
Contact Name*	
Title or Function	
Telephone number*	
Email*	

3. Return acknowledgement to Sender	
Email	emea-fsca-neuro@integralife.com
Customer Helpline	+33 (0) 6 38 15 85 03
Postal Address	Post Market Surveillance Department Integra Immeuble Séquoia 2, 97 allée Alexandre Borodine Parc technologique de la Porte des Alpes 69800 Saint Priest, France
Web Portal	https://integralife.eu/
Fax	+33 (0)4 37 47 59 30
Deadline for returning the Customer reply form*	20/07/2022

4. Customer action undertaken on behalf of Healthcare Organisation		
<input type="checkbox"/>	I confirm receipt of the Field Safety Notice and that I read and understood its content. *	<i>Customer to complete or enter N/A</i>
<input type="checkbox"/>	I performed all actions requested by the FSN.	<i>Customer to complete or enter N/A</i>
<input type="checkbox"/>	The information and required actions have been brought to the attention of all relevant users and executed.	<i>Customer to complete or enter N/A</i>
<input type="checkbox"/>	No concerned devices	<i>Customer to complete or enter N/A</i>
<input type="checkbox"/>	Other Action (Define):	
<input type="checkbox"/>	I have a query, please contact me	<i>Customer to enter contact details if different from above and brief description of query</i>
Print Name*		Customer print name here
Signature*		Customer sign here
Date*		

Mandatory fields are marked with *

It is important that your organization takes the actions detailed in the FSN and confirms that you have received the FSN.

Your organization's reply is the evidence we need to monitor the progress of the corrective actions.